

**Connectors
Fittings
Connecting Technology**

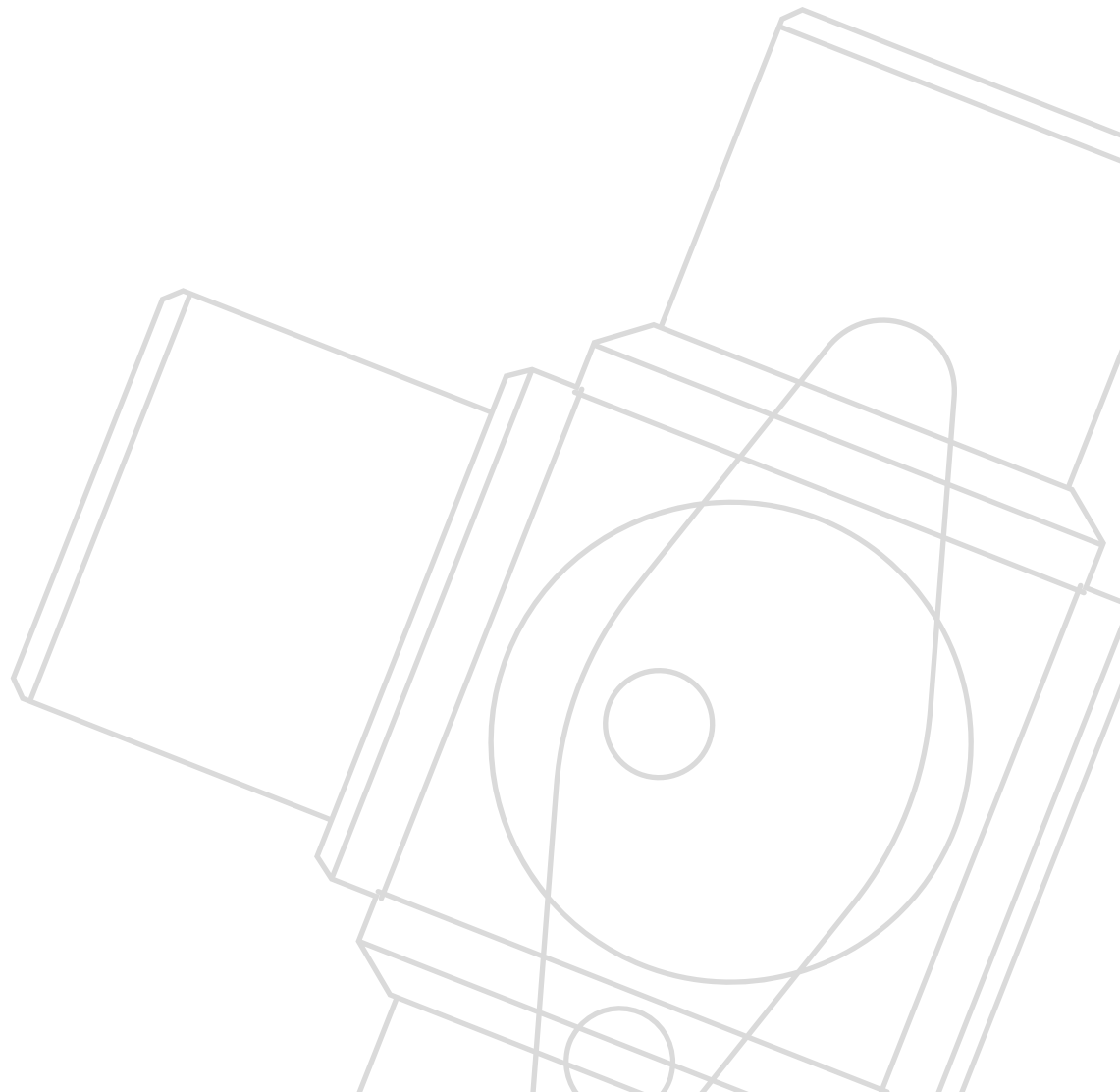



emtechnik is a medium-sized family-owned company and is one of the world's leading manufacturers of connectors and fittings made of special plastics.

Welcome



Dear customers, interested parties
and business partners,

The success story of **emtechnik** began in 1965 with the founding by my father Norbert Meier, at that time still based in Ludwigshafen.

From the very beginning the focus was on the development and manufacture of connectors and fittings in small nominal diameters, exclusively made from special plastics. Although our modular product range has been evolved continuously, a large number of system solutions are still in use today. Added to this are the expansion on global sales markets in recent decades through our own sales subsidiaries and dealer networks together with the expansion and specification of our product portfolio.

According to the motto 'everything from one source' we offer solutions of highest quality all around connecting, regulating, shutting-off, filtering, measuring and distributing of media flows.

Thanks to technical innovations, a number of our products and product series have been very successful on the market and have established themselves as solutions for our customers. Pleased by this success we are highly motivated and optimistically looking into the future. In this way, we will meet the changing market conditions as well as the complex requirements of our customers and look forward to the challenges ahead together with you.

A handwritten signature in purple ink that reads "Michael Meier".

Michael Meier, Managing Director (CEO)

- 06** Industry Competence
- 10** High-Tech Products Made of Plastic
- 12** Approvals and Standards
- 14** Modular Product System
- 18** Products in Use
- 22** Products
- 38** The Company emtechnik

Competence in All Areas

We want to offer our customers a comprehensive range of products for all industries. Driven by this mission statement and empowered by many years of experience **emtechnik** is constantly engaged in developing new solutions.

Our extensive product portfolio results from the many possible combinations. We are also able to manufacture individual product solutions, precisely tailored to industry-specific requirements.



Semiconductor Industry



Chemistry



Water



Food



Laboratory & Research



Green Energy



Pharmaceutical & Medical Technology

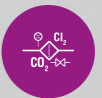

Process Analytical Technology

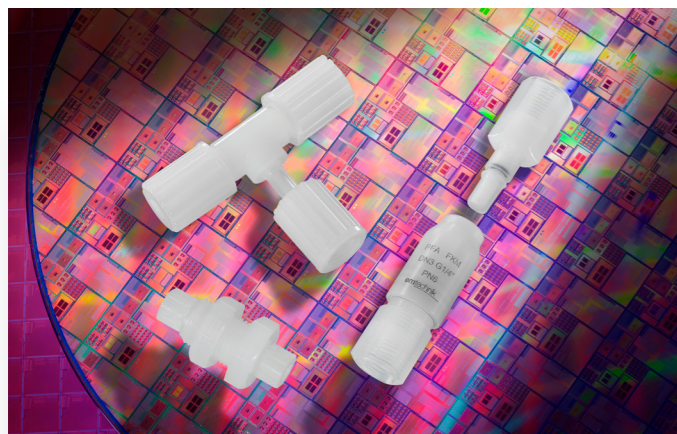

Semiconductor Industry

Not just clean, but pure

In production for the semiconductor industry, we pay particular attention to cleanliness and purity. Not only the processed material in HP quality, but also the production of our connectors, valves, ball valves, flow meters and filters meets the highest requirements. For example, many **emtechnik** products are manufactured in a clean room in accordance with ISO 14644-1 Class 5. Subsequent cleaning and packaging are also carried out in a controlled environment. In this way, we guarantee compliance with the highest standards along the supply chain.



Chemistry

When things get hot we stay cool

In the process industry, highly aggressive chemicals are used. The demands on the tightness of the fittings and valves used are correspondingly high. Equipment manufacturers and plant constructors in process technology will find a solution for almost every application at **emtechnik**. We process fluoroplastics especially for this area. High chemical and thermal resistance guarantee corrosion-free continuous use and ensure maximum safety.



Water

Water is life

Water is the most valuable resource on our planet and clean drinking water is a crucial factor for the quality of life. For device and plant engineering in water technology, **emtechnik's** connectors and fittings offer a wide range of solutions. Especially in analysis and dosing technology, we are able to make an important contribution to the treatment of drinking and process water. Therefore we use plastics such as natural PP, PVDF or PFA.



Food

A partner for good taste

In the food industry, there are many use cases for plastics. During cleaning processes (CIP/SIP), e.g. during the disinfection of bottling plants and their pipings, aggressive chemicals need to be dosed. In combination with high temperatures, only high-quality plastics can withstand these conditions. The plastics used by **emtechnik** meet these requirements. In addition, we adhere to the current EU and US standards for usage in the food sector. In this way, we achieve the highest level of hygiene safety.



Laboratory & Research

Secure and reliable even on a small scale

Sometimes it has to be a little smaller. **emtechnik** offers a large selection of suitable GL connectors, screw fittings, ball valves and hoses for use in laboratory and research. They can be used compactly and flexibly even for setting up tests on a small scale. With our large selection of materials, for example PP, natural PP, PVDF or PFA, there is certainly something for your application.



Green Energy

Plastics for the energy transition

No new energies without plastics. Developing new sustainable technologies, plastics are getting used more and more often. Good examples are innovative battery technologies, wind turbines, photovoltaic systems and the field of hydrogen technology. The fittings and valves from **emtechnik** make a valuable contribution to efficiently supporting the process chain in regenerative energy generation.



Pharmaceutical & Medical Technology

Health is the greatest good

Our fittings, valves, ball valves, flow meters and filters for the pharmaceutical industry and medical technology are subject to strict specifications. The raw materials used by **emtechnik** meet all USP Class VI criteria and are also ADI-free. Combining our in-process quality controls, seamless documentation of the manufacturing process and production in our own ISO 14644-1 Class 5 clean room, we meet the quality requirements of this industry.



Process Analytical Technology

Safety knows no compromise

Our unique product diversity offers the appropriate components for the integration of process instrumentation. In the field of process analysis, you will find everything you need for the implementation of innovative analysis technologies. Our large selection of fittings, valves, ball valves, flow meters and filters enable you to connect, regulate, shut off and measure safely and precisely. We offer these in a wide range of fluoroplastics such as PVDF, PFA or PTFE. With our products, the safe analysis of aggressive liquids and gases succeeds in compliance with strict legal requirements.

High-Tech Products Made of Plastic

The following plastics are currently in use for a variety of applications: PP, Natural PP, PVDF, PFA, PEEK, Organic PA, ECTFE and PTFE.

Due to their highly technical properties, they have numerous advantages and are often used where other materials fail.

For handling media in potentially explosive environments, our products are available in electrically conductive PP-EL, PVDF-EL and PTFE-EL. To prevent electrostatic charges from accumulating, electrically conducting particles are mixed into these high-performance materials.

Our products made of fluoroplastics are an optimum solution for outdoor applications, as they are resistant to UV radiation.

ECTFE, PFA, PVDF and PTFE are heat and pressure-resistant and can therefore be sterilised in an autoclave without any problems. Our products made of PEEK can withstand high mechanical stresses



PP

- FDA approval
- Good chemical resistance against alkalis
- Particularly lightweight
- Electrically conductive available



Natural PP

- FDA approval
- Good chemical resistance against alkalis
- Particularly lightweight
- Transparent



PVDF

- FDA approval
- USP Class VI approval
- ADI-free
- Good chemical resistance against acids
- Radiation / Steam sterilisable
- UV-stable
- Electrically conductive available



PFA

- FDA approval
- USP Class VI approval
- ADI-free
- Excellent chemical resistance against acids and alkalis
- Steam sterilisable
- UV-stable
- Suitable for use at high temperatures

Product Materials

ISO-Code	Material	Colour	Operating Temperature	Tensile Strength at 23°C	EU No. 10/2011	FDA	USP VI	ADI-free
PP	Polypropylene	grey	+5 to +90°C	25 to 30 N/mm ²	●	●		
PP-EL	Polypropylene	black	+5 to +90°C	20 N/mm ²				
Natural PP	Polypropylene	milky transparent	+5 to +90°C	25 to 30 N/mm ²	●	●		
PVDF	Polyvinylidene fluoride	natural	-40 to +140°C	50 N/mm ²	●	●	●	●
PVDF-EL	Polyvinylidene fluoride	black	-40 to +140°C	50 N/mm ²				
PFA	Perfluoralkoxy	transparent	-200 to +200°C	~ 29 N/mm ²	●	●	●	●
PEEK	Polyetheretherketone	brown/grey	-65 to +250°C	80 N/mm ²	○	○		●
Organic PA	Polyamide	natural	-20 to +60°C	54 N/mm ²		●		
ECTFE	Ethylene chlorotrifluoroethylene	beige	-40 to +140°C	~ 30 N/mm ²				●
PTFE	Polytetrafluoroethylene	white	-200 to +260°C	27 N/mm ²	●	●	●	●
PTFE-EL	Polytetrafluoroethylene	black	-200 to +260°C	10 to 13 N/mm ²	○	●		

Sealing Materials

ISO-Code	Material	Colour	Operating Temperature	Shore Hardness	FDA	USP VI
FKM	Fluorinated rubber	black	-15 to +200°C	~80 N/mm ²	○	○
EPDM	Ethylene propylene diene monomer	black	-50 to +140°C	~70 N/mm ²	○	○
FFKM	Perfluor rubber	black	-20 to +275°C	75 N/mm ²	○	○
Gylon®	Polytetrafluoroethylene	blue	-210 to +260°C		●	●

Natural PP, PFA, PTFE and PVDF are also available at clean room quality level. ● Standard ○ on request



PEEK

- Good chemical resistance against alkalis and flue gas
- Radiation / Steam sterilisable
- Very good mechanical properties



Organic PA

- FDA approval
- Made from renewable raw materials



ECTFE

- ADI-free
- Good chemical resistance against acids and alkalis
- Steam sterilisable
- UV-stable



PTFE

- FDA approval
- ADI-free
- Excellent chemical resistance against acids and alkalis
- Steam sterilisable
- UV-stable and suitable for use at high temperatures
- Electrically conductive available

Approvals and Standards



Resistance to Aggressive Media

Plastics can come into contact with a wide range of different liquids and chemicals during use. **emtechnik** products have long-term resistance to aggressive media in numerous applications and are also resistant in aggressive environments.



High Purity

emtechnik has ISO 14644-1 Class 5 and 7 clean rooms, which allow us to manufacture, clean and assemble our products in a contamination-free atmosphere.



USP Class VI

emtechnik uses materials that comply with the current standards regarding the quality of medications and other medical technology products (USP Class VI).



RoHS

The raw materials used by **emtechnik** meet the requirements of the RoHS Directive 2011/65/EU. That means they contain no lead, cadmium, chromium VI, mercury or the flame retardants PBB and PDBE or the plasticisers DEHP, BBP, DBP and DIBP, and that such materials are also not used anywhere in the production process.



Electrically Conducting

To prevent electrostatic charging, the high-performance materials PP, PVDF and PTFE are equipped with electrically conductive particles and have an extremely low surface resistance of $< 10^3 \Omega$ or $< 10^2 \Omega$. PVDF-EL and PTFE-EL are also UV-resistant.

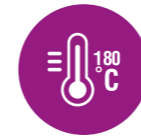

High Temperature Compatibility

Our versatile connector types are the ideal solution if you are operating with aggressive media at very high temperatures. The outstanding chemical properties, high operational reliability and special connection principles meet all the requirements for working with high-temperature media.



Food Safety

emtechnik offers a broad range of food-safe plastics that comply either with the regulations of US American Food and Drug Administration FDA and/or the European regulations of 1935/2004/EC. The plastics used also comply with the Regulation on Materials and Articles intended to come into contact with foodstuffs (10/2011/EU).



No Dead Volume

A conical, thread end without seams for both the female and male thread of the connector or ball valve guarantees a connection with no dead volume. This ensures that no bacteria can become lodged, media do not crystallise and dirt particles cannot adhere.



REACH

In accordance with REACH Regulation 1907/2006/EC of the European Chemicals Regulation on the Registration, Evaluation, Authorisation and Restriction of Chemicals, the products manufactured by **emtechnik** do not contain any substances subject to authorisation in a concentration greater than 0.1 w/w.



Sterile

PVDF and PFA are also suitable for hot steam sterilisation – the indispensable requirement for absolute sterility. PVDF is autoclavable at 134°C or can be sterilised with γ -radiation while fully retaining its mechanical properties (maximum dosage 25 – 50 kGy). PVDF is non-toxic in the range $< 150^\circ\text{C}$ and does not provide any breeding ground for microorganisms, since it behaves very similarly to glass.



ADI-free

In order to avoid any contamination with animal constituents such as BSE pathogens in the production process, **emtechnik** offers products made from plastics classified as ADI-free.

Our Modular Product System



emtechnik products are based on a modular system.

Since their functions are coordinated and can be variably combined with each other, together they can build almost any application.

From individual modules to complex application concepts, we offer perfect solutions that are precisely tailored to your requirement profile – everything from one source.

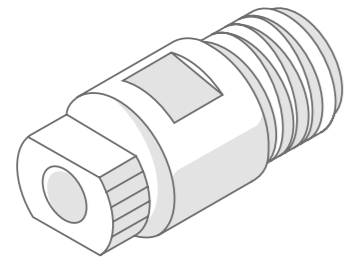

Connecting

The variety of our couplings with various connection principles enables the reliable and secure connection of tubes or pipes in a wide range of materials – even with high industry-specific requirements.

Filtering

Our filters can be used for a wide range of applications and are safe and easy to handle. They reliably clean gases and liquids and are available as particle filters or coalescence filters. Different porosities are available for specific applications.

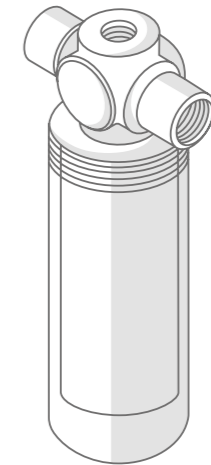

Regulating

Our products are used wherever gas and liquid flows have to be regulated – particularly in applications with aggressive media. Even very low flow rates can be precisely regulated.

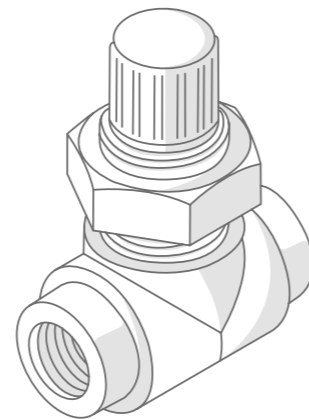

Measuring

The **emtechnik** fittings precisely measure volumetric flows or pressure and provide exact measurement results. They can be used in different measurement ranges. The fittings can easily be integrated into existing applications.

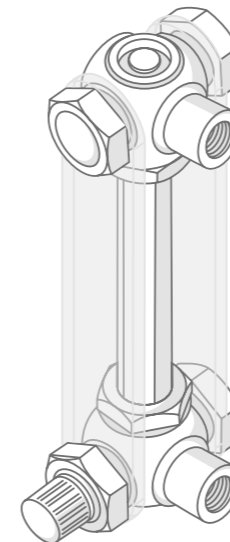

Shutting Off

Shut-off products from **emtechnik** feature an impressive design with absolute leak tightness and compact construction. The media flow is safely and reliably shut off and is conducive to flow inside the products.

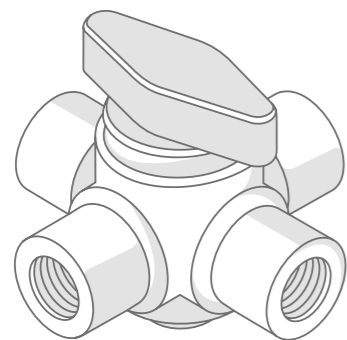

Distributing

Manifolds from **emtechnik** are the ideal solution wherever media are distributed or collected. Depending on the application, the media can be either distributed directly or shut off as required using the appropriate fittings.

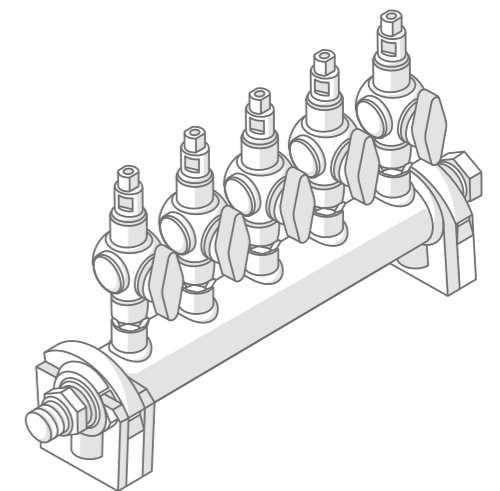

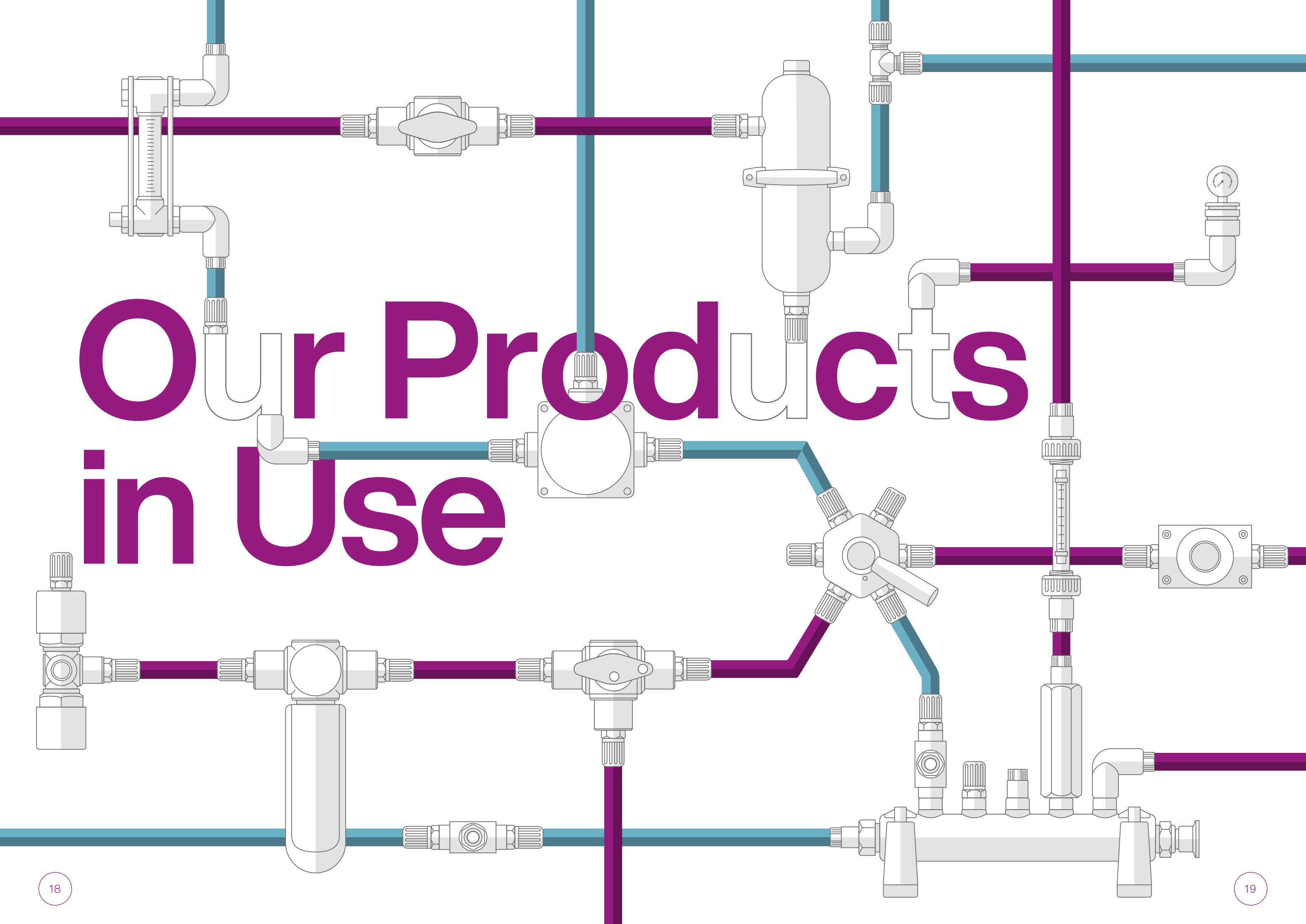

Our Products in Use

Products for Your Applications

Our products are used wherever liquid or gaseous aggressive media are handled in small nominal diameters.

Our miniature fittings and connectors meet the highest standards of material purity, media resistance and reliability for the application. Against this background, **emtechnik** products form a modular system in which every part is compatible and can be used for variable applications. We are a one-stop solution provider for many applications and our products are precisely tailored to our customers' requirements. Our modular product line now consists of over 10,000 articles and includes a wide range of connectors, valves, ball valves, flow meters, filters and distribution systems.



Connecting



Filtering



Regulating

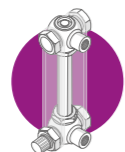

Measuring



Shutting Off



Distributing

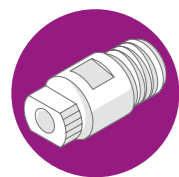

Connecting | Our Generation+

Compact design, sturdy construction and simple handling. All Generation+ products are made of only two parts with an integral clamping ring. They feature threads and connecting sleeves without seams and can be installed multiple times.

Materials: PP, natural PP, PVDF, PFA

Nominal DN04/06 – DN18/20,

Diameters: DN1/8"/1/4" – DN7/8"/1"

Thread: G1/8" – G1", NPT1/8" – NPT1", UNF

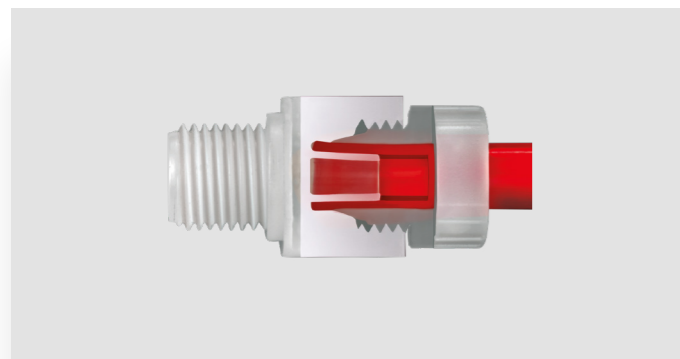

Connection Principle 1+

- Can be assembled multiple times without loss of quality
- Absolutely leak-proof and reliable
- Pressure stage PN16

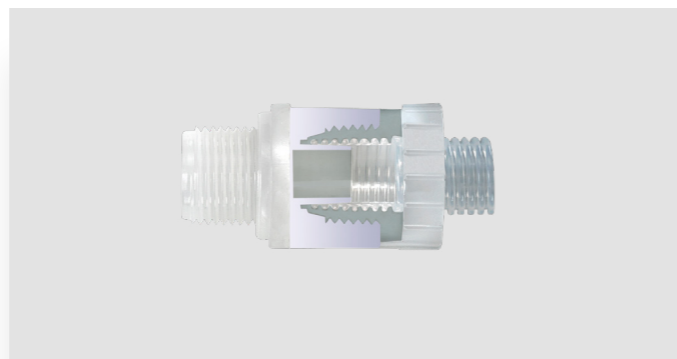

Connection Principle 1W+

- Flexible tube connector for corrugated flexible tube with smooth inside surface
- No pre-assembly necessary
- Flexible tube-related pressure stage PN04 for PP and PVDF

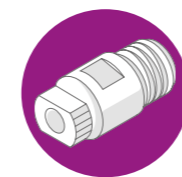

Connecting | Flexible Tube Connectors

Different connection principles are available for connecting flexible tubes, depending on the materials and wall thicknesses. All products feature seamless threads and sleeves and can be assembled several times.

Materials: PP, natural PP, PVDF, PFA

Nominal DN04/06 – DN18/20,

Diameters: DN1/8"/1/4" – DN7/8"/1"

Thread: G1/8" – G1", NPT1/8" – NPT1", UNF

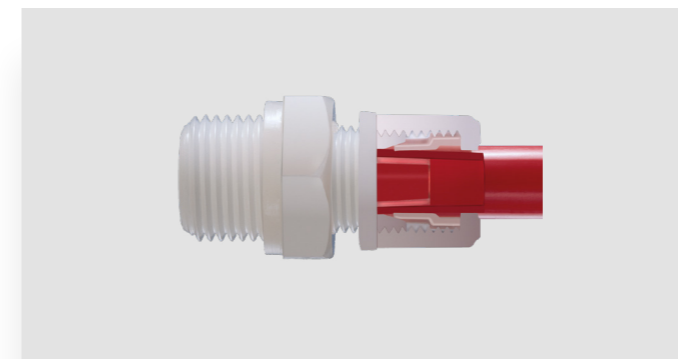

Connection Principle 1A

- Flexible tube is pushed onto the integrated connecting sleeve
- Pressure stage PN10
- Locking via clamping ring
- Securing via knurled nut
- No tube strain beyond 6%

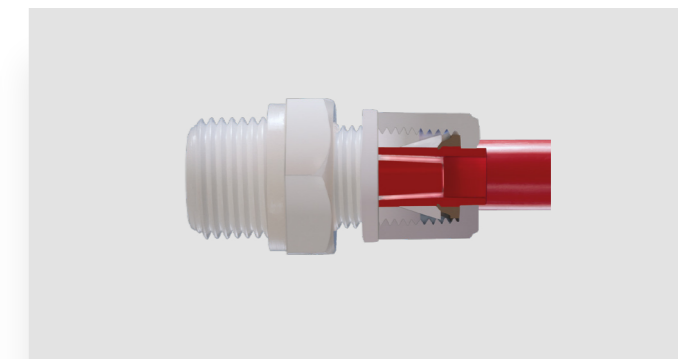

Connection Principle 1C

- For high-temperature applications
- For firm flexible tubes, for example PFA
- Flexible tube is pushed onto the integrated connecting sleeve
- Sealing with PTFE sealing ring
- Locking via cutting ring made of PEEK and knurled nut

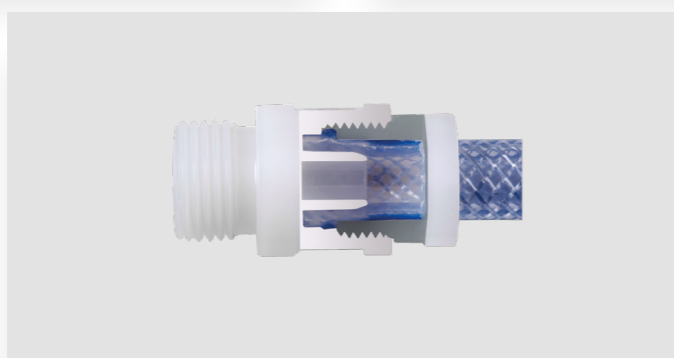

Connection Principle 1B+

- Flexible tube connector for fabric-reinforced flexible tubes
- Media-resistant materials: PP, PVDF
- Pressure stage PN16 for PP and PVDF (brief pressure peaks of up to 30 bar possible at T = 20°C)
- Also available in organic PA

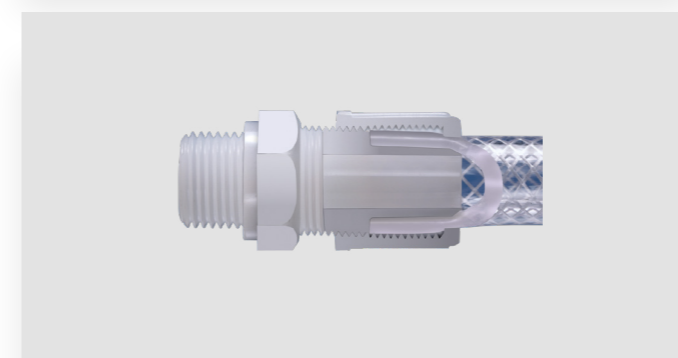

Connection Principle 1B

- Fabric-reinforced flexible tube spreads when pushed onto the integrated connecting sleeve
- Pressure stage PN10 (brief pressure peaks of up to 30 bar at T = 20°C possible)
- Locking via knurled nut

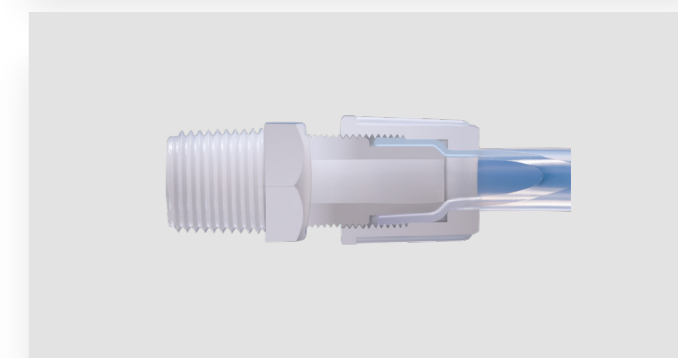

Connection Principle 1D

- Flare connection with no dead volume
 - No particle deposits
 - No accumulation of bacteria
 - No media leakage
- Tools available for hose expansion
- HP quality in natural PP, PVDF and PFA



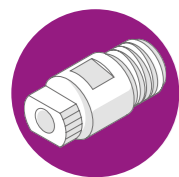

Connecting | Pipe Connectors

To connect rigid tubes and pipes with an external diameter from 1.6 mm to 25 mm, the following reusable connection principles without connecting sleeve are available.

Materials: PP, natural PP, PVDF, PFA, PEEK

Nominal Diameters: D1.6 – D25, D1/8" – D1"

Thread: G1/8" – G1", NPT1/8" – NPT1",
M10x1 – M26x1,5, UNF

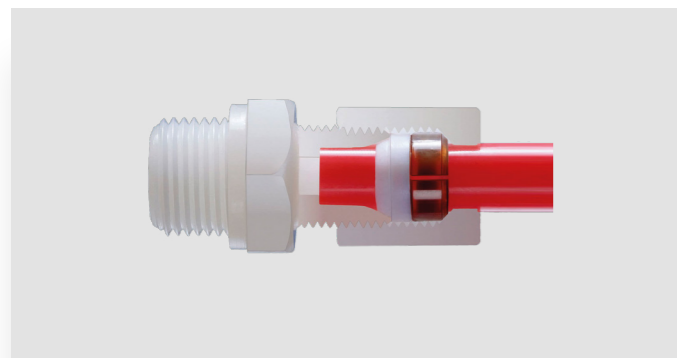

Connection Principle 2N

- Sealing provided by sealing ring made of PTFE
- Pressure stage PN10
- Locking via cutting ring and nut
- No reduction of cross-section

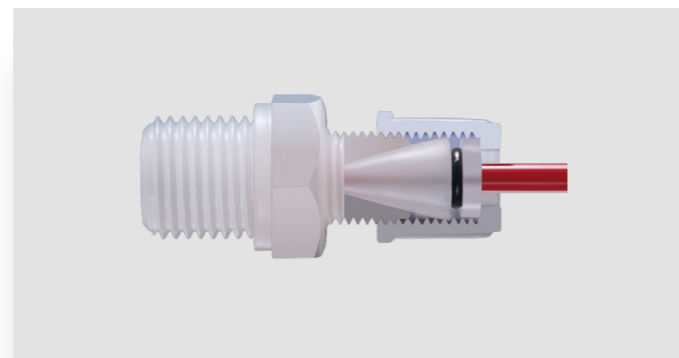

Connection Principle 2M

- Specially for thin pipes with external diameter 1.6 mm – 6.35 mm
- Sealing provided by sealing cone made of PTFE
- O-ring holds capillary tube
- No reduction of cross-section
- Pressure disc protects O-ring against damage

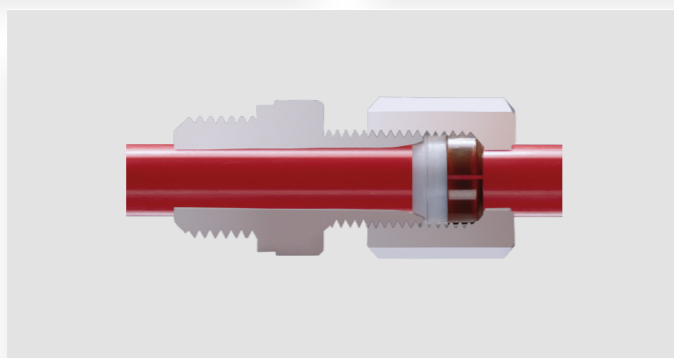

Connection Principle 2D

- Pipe opening
- Sealing provided by sealing ring made of PTFE
- Locking via cutting ring and nut

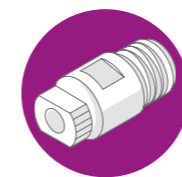

Connecting | Other Connection Types

Materials: PP, natural PP, PVDF, PFA, PTFE, PEEK

Nominal Diameters: D1.6 – D25, D1/8" – D1", DN04/06 – DN18/20, DN1/8"/1/4" – DN7/8"/1"

Thread: G1/8" – G1", NPT1/8" – NPT1"



Tri-Clamp Connectors 3C

- Quick connection with locking clip made of stainless steel or plastic
- Size, diameter and locking clip in accordance with DIN 32676, ISO 2852, BS 4825
- Matching flange sealings of EPDM, FKM, PTFE, FFKM and Gylon® available



Quick Connectors 3K

- Coupling and nipple can be shut off
- Housing made of PVDF: Spring made of PEEK, 1.4571 or Hastelloy® possible
- Housing made of PFA: Spring made of TFM 1600
- Connections for flexible tube up to DN 10/12



Elbow Swivel Connectors 1A

- Easy and convenient assembly
- Permanently swivelling
- Leak-proof and secure connection, even with continuous rotation
- Sealing with media-resistant housing materials and O-rings

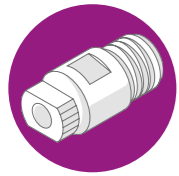

Connecting | Other Connection Types

Materials: PP, natural PP, PVDF, PFA, PTFE, PEEK

Nominal Diameters: D1.6 – D25, D1/8" – D1", DN04/06 – DN18/20, DN1/8"/1/4" – DN7/8"/1"

Thread: G1/8" – G1", NPT1/8" – NPT1", M5 – M24x1,5



Luer Lock Adapter 3L

- Allows for quick connection
- Luer lock thread without seam according to DIN EN 20594-1 or ISO 594
- Depending on material, can be autoclaved at 134°C or sterilised with γ -radiation



Glass Thread Adapter 3G

- Standard GL thread connection
- Sealing with media-resistant FKM O-ring
- Permanently leak-proof and reliable connection



3F Fittings

- Nipples: with male threads
- Unions: with female threads
- Reducers: with different male and female threads and combinations of different thread sizes
- Flanges: are used for detachable connection of pipes



Welding Tube Adapter 3W

- Various connection principles for flexible tube and pipe connections
- Wall thickness of welding unions as defined by DIN ISO 10931
- Suitable for butt and socket welding methods
- Standard range complemented by a variety of reducers

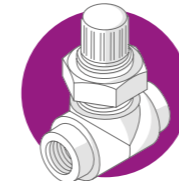

Regulating

We offer valves in different materials as a suitable and reliable solution for regulating the flow of media, especially for use with aggressive media.

Materials: PP, natural PP, PVDF, PFA, PTFE

Nominal Diameters: DN04 – DN10

Thread: G1/8" – G1/2", NPT1/8" – NPT1/2"



Regulation Valves 5C

- Regulating and shutting off gas and liquid flows
- For panel mounting
- Particularly light and compact design
- Maintenance-free design



Fine Control Valves 5A

- Linear flow rate characteristics for precision control
- Manual with adjustment scale for reproducible settings
- Spindle specifically matched to the flow range



Fine Control Valves 5E

- Volumetric flows can be precisely determined via input signal (4 to 20 mA)
- Spindle position can be exactly approached
- Linear characteristic



Pressure Reducing Valves 5D

- For reducing system pressures to largely constant working pressures
- Valve adjustment also possible at working pressure
- Hermetically leak-proof by valve diaphragms made of PTFE



Pressure Keeping Valves 5D

- Safe elimination of pressure peaks and pulses
- Valve adjustment also possible at working pressure
- Small hysteresis
- Any installation position



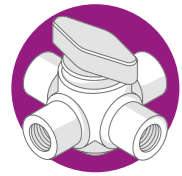

Shutting Off

To shut off aggressive gases and liquids safely and reliably and prevent return flow, we offer ball valves, check valves and other solutions.

Materials: PP, natural PP, PVDF, PFA
Nominal Diameters: DN02 – DN15
Thread: G1/16" – G3/4", NPT1/8" – NPT1/2"



Ball Valves 6L

- 2-way to 5-way ball valves are available (7, 9, 11-way ball valves on request)
- With seamless female thread
- Various fastening options
- Electrical or pneumatic part-turn actuators possible



optionally with app

Electrical Ball Valves 6R

- With visual position indicator (optional)
- DC micro-motor with planetary gear
- Wear-free Hall sensors as position indicator
- Motor housing is made of impact-resistant PP
- Can be connected directly to PLC or PCS
- Bluetooth app, password-protected



Plug valves 6T

- No dead volume, with integrated connection for pipe
- Without O-rings
- Maximum chemical and thermal resistance (-40°C to +150°C)
- Compact design
- Can be sterilised with hot steam
- Suitable for use in food products and available in USP-Class VI

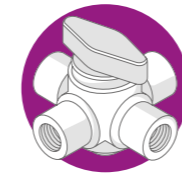

Shutting Off

Materials: PP, natural PP, PVDF, PFA
Nominal Diameters: DN02 – DN15
Thread: G1/16" – G1/2", NPT1/8" – NPT1/2"



Check Valves 5R

- Prevent return flow/back blow of media in systems
- Compact version with integrated flexible tube connectors for direct inline installation
- Spring made of Hastelloy® or PCTFE
- Also for low opening pressures of 10 mbar and up



Diaphragm Valves 5P

- Pneumatically controlled safety fitting (NC, NO or double-acting)
- Nominal diameter DN05
- Sealing principle: Diaphragm with 90° cone made of FFKM
- Design with no dead space



Shut-off Valves 5A

- According to DIN 12266 → Maximum quality control
- Low-wear valve seat
- Streamlined design
- Suitable for wall mounting



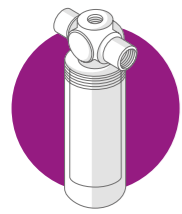

Filtering

Versatile, safe and easy to handle, our 7F series particle or coalescence filters reliably clean the gases or liquids used. Various filter types with filter grades from 0.3 µm to 100 µm are available for individual applications.

Materials:	PP, natural PP, PVDF, PFA, PTFE
Nominal Diameters:	available on request
Thread:	G1/8", G1/4", G3/8", G1/2"
Connections:	DN04/06 – DN10/12



Tube Filter 7F

- With female G-thread on both sides
- Particle or coalescence filter
- Easy filter change
- Available with shut-off or drain



Tri-Clamp Filter 7F

- With seal and bracket
- With G male thread on both sides
- For inline installation
- Can be upgraded in existing installations
- Also with integrated flexible tube connectors



Macrofilter 7F

- For liquid media
- With female G-thread



Inline Filter 7F

- With connection for flexible tube on both sides
- Small and compact
- Easy to replace and upgrade
- For inline installation
- For air only



Mounted Filter 7F

- For front panel installation or in 19" racks (e.g. in analysis systems)
- Viewing glass for assessing the degree of soiling
- Connectors Inside, Filters Outside
- Fast and easy filter replacement from outside

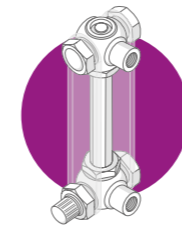

Measuring

Our flow meters use the float principle and are suitable for exact measurement of gases and liquids. Diaphragm pressure gauges with manometer are available for measuring pressure in neutral and aggressive media. Individual measuring ranges and different types of measurement acquisition are possible.

Materials:	PP, natural PP, PVDF, PFA, PTFE
Nominal Diameters:	DN04 – DN10
Thread:	G1/8" – G1/2", NPT1/8" – NPT1/2"
Connections:	DN04/06 – DN06/08



Flow Meter 4Z

- Measuring tube made of DURAN® glass
- With G or NPT-thread
- Sealing with PTFE cone
- Regulation option by handle
- Connection options on the rear, side, inline
- Compatible with various ring initiators



Mini Flow Meter 4M

- For very small flow rates
- With connection for flexible tube on the back
- Measuring tube made of DURAN® glass



Diaphragm Pressure Gauge 3D

- Different pressure measurement ranges
- Reliable protection of the manometer from aggressive media
- With welding union, G female or male thread
- With retaining bracket



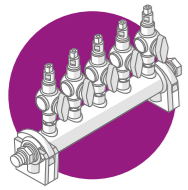

Distributing

Manifolds from **emtechnik** are the ideal solution wherever media are distributed or collected. Our series 8B offers standard manifolds in various designs and materials. We also offer customised solutions to your individual specifications.

Depending on the application, the medium can be either distributed directly, shut off or regulated as required using the appropriate fittings.



Compact Manifolds 8C

- Convincing with very small sizes
- Available 1-sided with 2 to 5 outlets or double-sided with 2, 6, 8 or 10 outlets
- Available with integrated connections for flexible tube 1+ (DN04/06, DN06/08) or threads (G1/8", G1/4")
- Available with side end pieces closed or with G3/8" or G1/2" threads
- All threaded connections can be designed with male or female threads



Special Manifolds 8B/8S

- Tailor-made to your specifications for material, length, shape, number and arrangement of outlets
- With integrated connectors and/or fittings of your choice
- For direct connection to flexible tubes or rigid pipes



Manifolds 8B

- Easy connection of several manifolds
- Depending on the application, the medium can be directly distributed or shut off
- Latest welding methods, e.g. computer-controlled infra-red welding, socket welding or rotation welding

Other Applications

Our **emtechnik** product line offers you applications for pumping, conveying, collecting, isolating and venting.

Our injectors stand for absolutely reliable and efficient delivery and mixing of two media. The basic principle is simple: a gaseous media is used for the actuator; this media escapes at high pressure and high speed from a nozzle. During this process the suction media is also drawn along and can be supplied to the downstream production process.



Conveying – Injectors 7G

- Gas jet pumps for use without auxiliary electrical energy
- No wearing parts

High Performance Injectors 7G

- New, two-part design with integrated sealing collar
- O-ring no longer required
- Better flow due to excellent ratio of volumetric flows of suction medium to propellant medium
- Less propellant and therefore less energy consumption



Collecting – Condensate Collectors 7K

- Safe and reliable collecting of condensed liquids
- Different volumes
- Containers made of DURAN® glass with GL drain



Containers 7K

- Condensate collectors, compensation tanks, mixing containers, special vessels
- For gases or liquids
- Collecting, mixing, storing or isolating



Individual Customer Solutions

Do you have a special application you are unable to cover with standard products?

Whether it requires modifications to one of our standard products or an individual combination of connectors and fittings to make a specific application ready for use as a 'Plant Panel':

Our engineers and technicians will find a solution for almost any problem that occupies our customers.

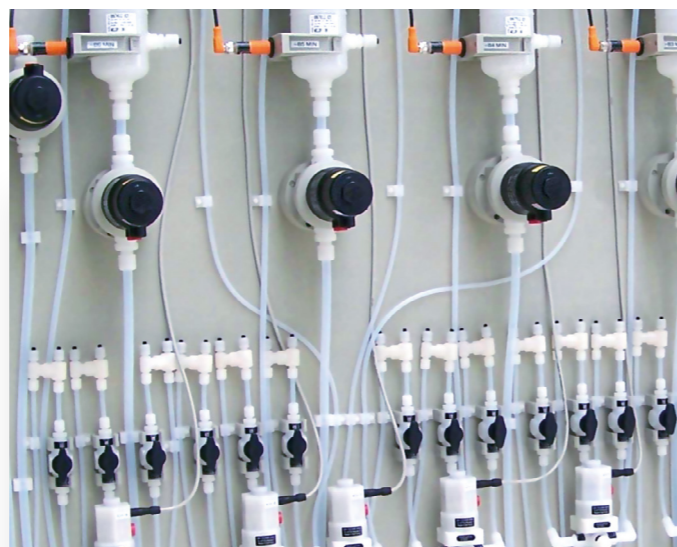

Plant Panels

We will produce your Plant Panel individually and specially for you, tailor made for your application. Everything is possible with our modularly structured product line, whether shutting off, dosing, controlling, distributing or measuring. You will receive your Plant Panel ready to use – planned according to your wishes and produced by us, fully assembled, tested and documented.



Specialist Ball Valves

Our ball valves can easily be combined with peripheral parts to produce fittings that cover a wider range of applications.



Sampling Pump

This pump was developed to simplify the sampling of liquids. The integrated flexible tube is immersed in the barrel. Pulling the handle draws 40 ml of liquid. The sampling glass can then be unscrewed.

Accessories and Sealings



Accessories for Connectors

- Plug caps
- Knurled and flat nuts
- Sealing, cutting and clamping rings
- Tube cutters



Sealings

- Suitable for all types and sizes of threads
- Tri-clamp sealings
- In various materials for many different possible applications

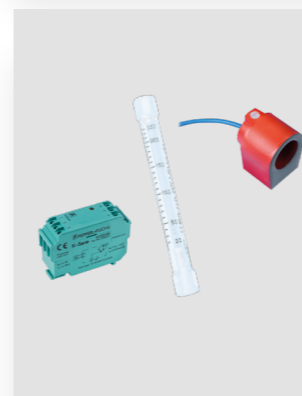

Accessories for Flow Meters

- Measuring tubes
- Annular proximity switchers
- Isolating amplifiers



Accessories for Ball Valves

- Fastening clamps
- Mounting brackets
- Drive systems



Accessories for Filters

- Filter diaphragms
- Filter cartridges

The emtechnik flexible tube product line

Through the combination of our flexible tubes and connectors, we supply solutions that are always tailored to the individual needs of the customers – true to the motto ‘everything from one source’. The flexible tubes from **emtubes** observe the standards of the corporate guidelines. To ensure this, they are strictly anchored in our quality management system.

Nominal Diameters:	DN01/03 – DN19/27, DN1/32"/1/16" – DN7/8"/1"	
Materials:	PU-ETFE: Media-resistant flexible tubes with high flexibility.	④
	PU-ETFE, fabric-reinforced: Flexible tubes with high pressure resistance.	①
	FEP: Flexible tubes with particular suitability for CIP processes. High transparency for outstanding media visibility.	
	FKM: Versatile flexible tubes for a wide range of industrial applications. High flexibility.	⑤
	PA: Compressed air flexible tube for pneumatic applications.	
	PE: Universally applicable with weak acids and alkalis.	⑥
	PFA: High transparency for outstanding media visibility. Universally resistant.	
	PTFE-corrugated flexible tube: Flexible tube with small bending radius and smooth inner wall.	⑦
	PTFE: Universally resistance to aggressive process conditions. Also available as electrically conductive for safe use in potentially explosive atmospheres.	②
	PVC: Flexible tubes with high resistance to water and organic solvents.	
	PVC, fabric-reinforced: High pressure resistance.	
	PVDF: Weathering and radiation-resistant with balanced properties.	
	Santoprene™: With very good recovery behaviour and good resistance to chemicals.	
	Silicone, fabric-reinforced: Glassfibre-reinforced for higher process reliability. Also available with USP Class VI.	③
	Silicone: Peroxide cross-linked flexible tubes with very good weathering resistance. Also available with USP Class VI.	

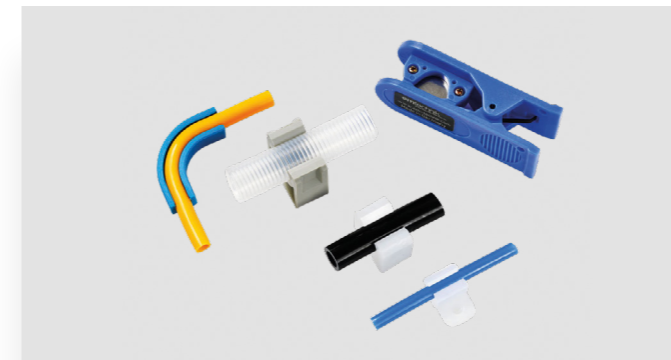

Flexible Tube Accessories

You need the appropriate tools for proper preparation and fixing of the flexible tubes. Whether tube cutter, angle clamp, pipe clamp or tube clip – you will find all the accessories for our extensive product range here.

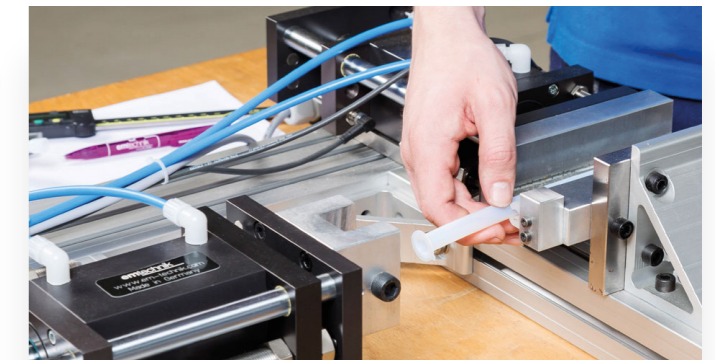

Processing and Assembly

We offer various services for customised flexible tube make-up, such as bending, crimping or flaring so that the flexible tubes fit perfectly, e.g. on the corresponding flare connectors. We can do all this and more for you.

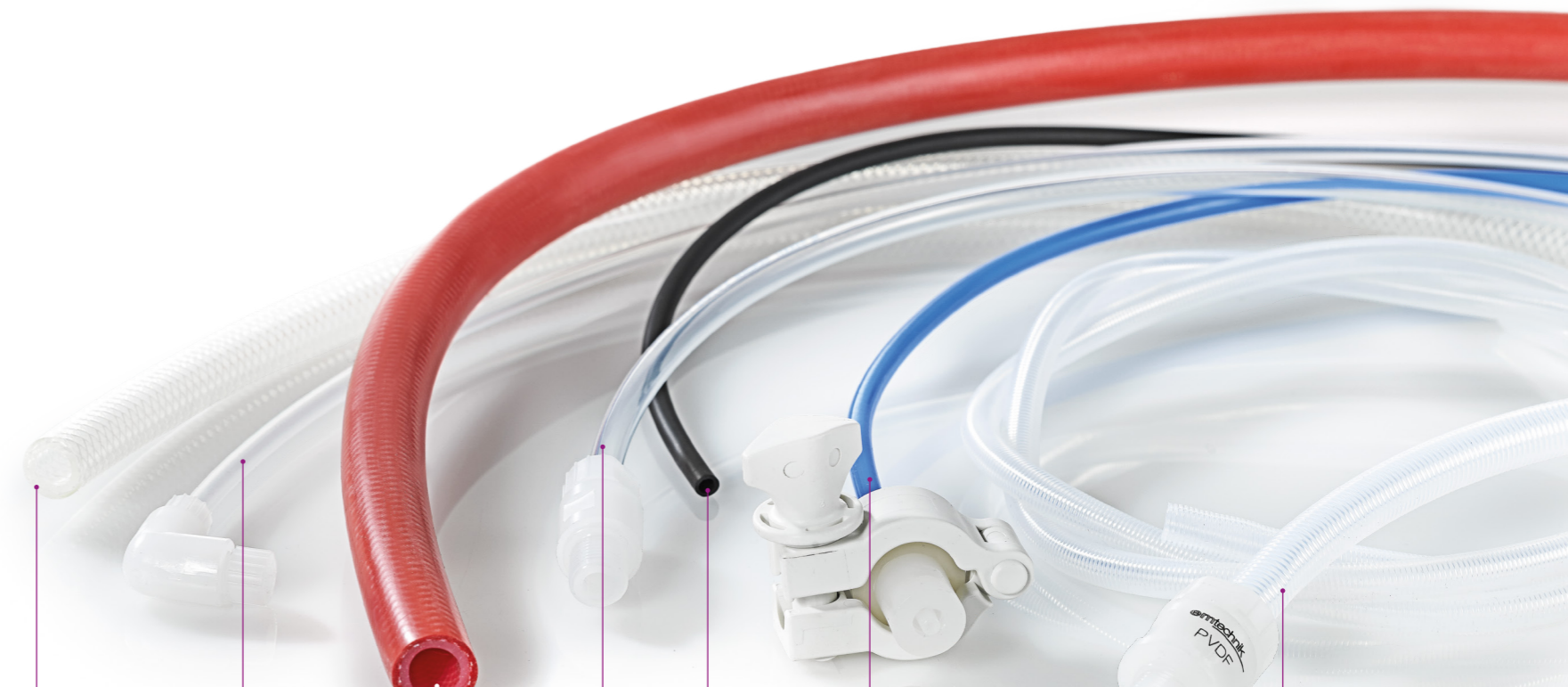

①

PU-ETFE,
fabric-reinforced

②

PTFE

③

Silicone,
fabric-reinforced

④

PU-ETFE

⑤

FKM

⑥

PE

⑦

PTFE-corrugated
flexible tube

The Company emtechnik



Competence and Quality for Your Objectives

emtechnik, a medium-sized family-owned company, is one of the world's leading manufacturers of high-quality miniature fittings and connectors made of special plastics. Our goal is to consistently develop high quality products from our customers' perspective.

Products are manufactured at **em**technik headquarter in Maxdorf, Germany through the combined efforts of over 100 employees. Various subsidiaries and representatives in Europe, Asia and the USA provide support and consulting for our customers in foreign markets.

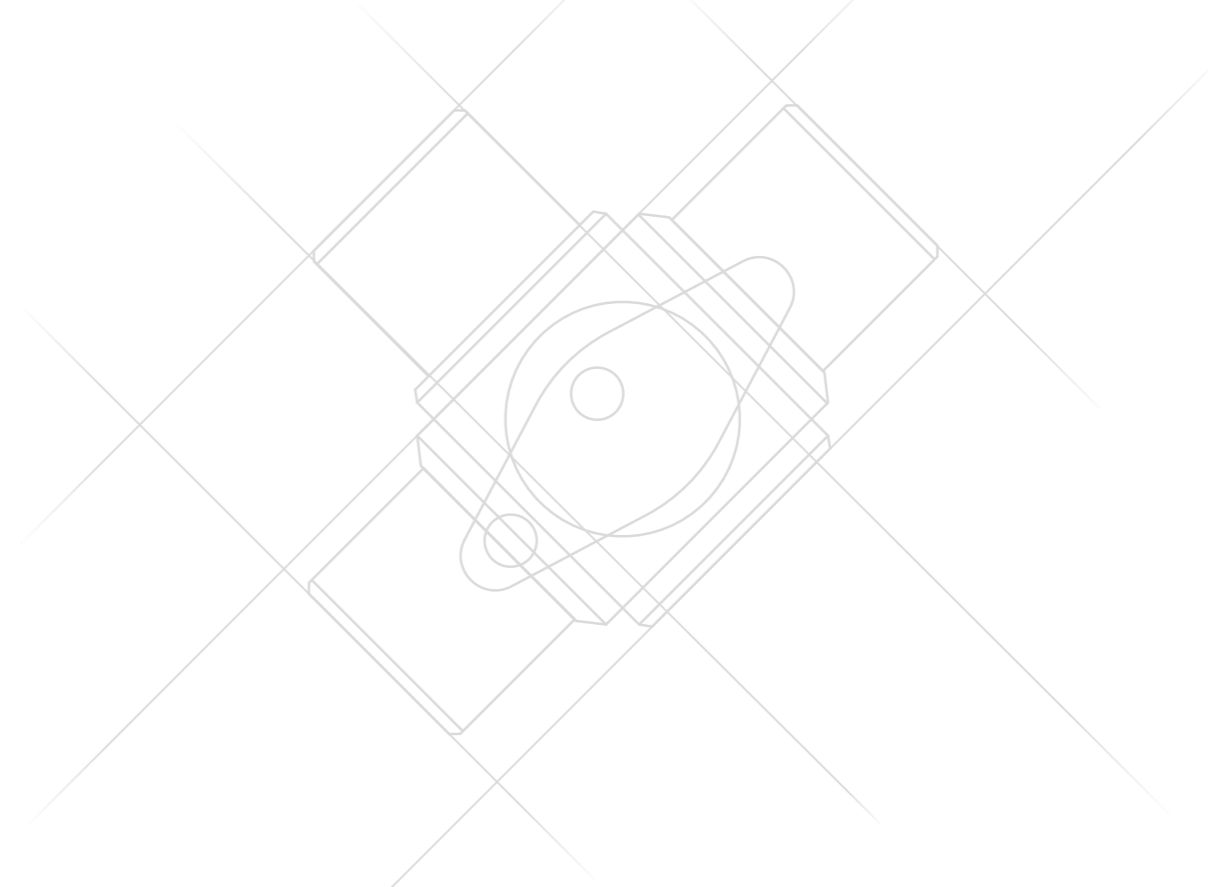
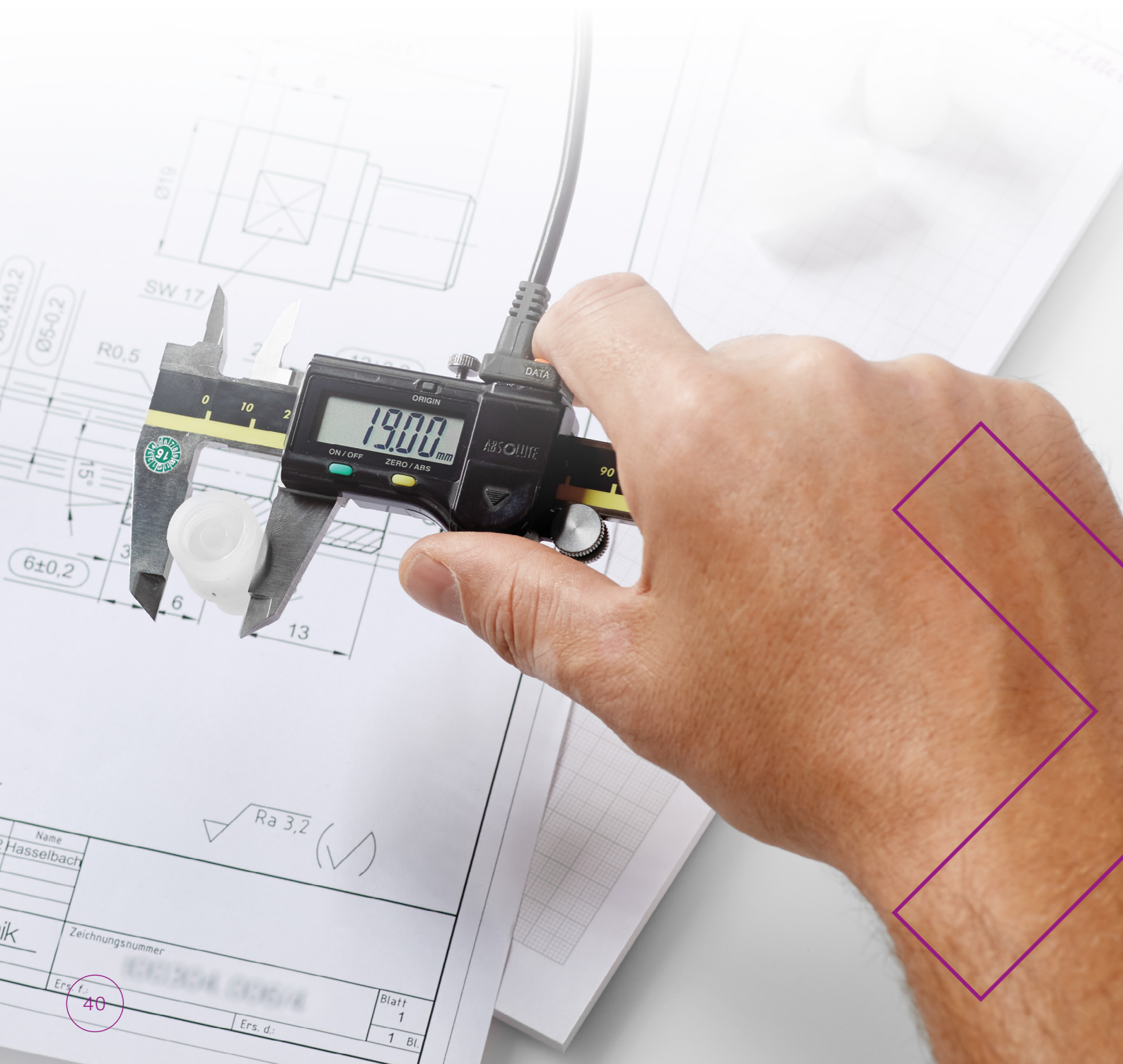

Safety without compromise for the most demanding requirements

Our extensive range of products form a modular system in which all parts can be used compatibly. In this way **em**technik products open up a wide range of applications that meet the most exacting demands for quality, safety and reliability.

We have set technical standards in many application areas with our products. We meet our high requirements for the performance capability of our products in a closely inter-meshed process of product development, manufacturing and quality management.

Guiding principles

Since we are exclusively using premium plastics, we are able to produce products with outstanding quality and high technological standards. It is very important for us to offer products from our own production. Our connectors and fittings are manufactured in nominal diameters from 1.6 to 25 mm or DN04-10 mm.

We offer our customers an optimum price/performance ratio and guarantee you the durability, leak tightness, chemical resistance and hence maximum operational reliability of our products. Taking into account all these aspects and uniform, sustainable actions, we are able to develop products for our customers that make their production processes easier and more reliable.

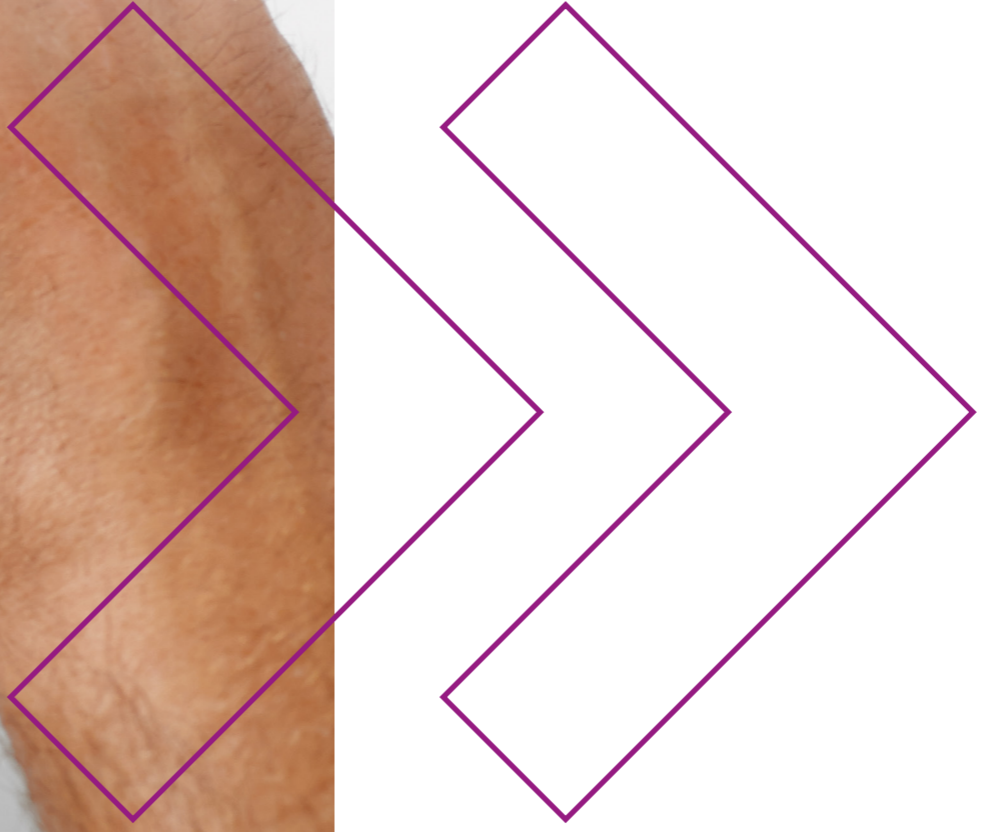

We Are Your Reliable International Partner

With subsidiaries in Belgium, France, Great Britain, Holland, Italy, Poland, India, Singapore, Taiwan and United Arab Emirates and as well as our representatives in Finland, Sweden, Spain and the USA, we provide direct local advice and support for our customers.

Our modular system makes it possible to implement a very wide range of application solutions. Whenever our solutions are not sufficient enough, we aim to develop innovative solutions especially tailored to your needs while keeping our **emtechnik** guiding principles in mind.

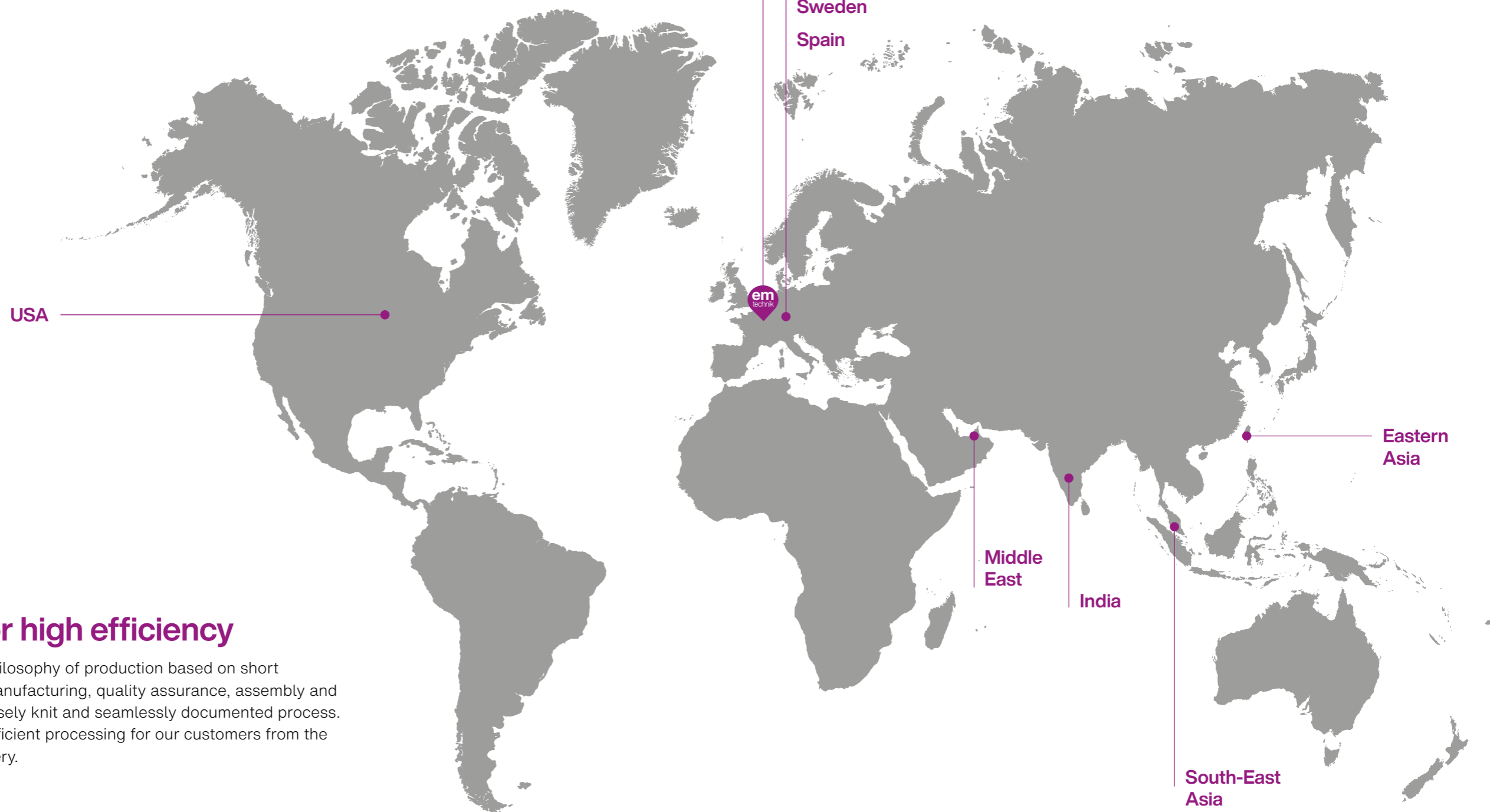

Short distances for high efficiency

emtechnik consistently follows a philosophy of production based on short distances. Product development, manufacturing, quality assurance, assembly and shipping are integrated into one closely knit and seamlessly documented process. This guarantees high quality and efficient processing for our customers from the time an order is received until delivery.

Our Philosophy

Success can only be achieved in close collaboration with all employees. Therefore, working in a team is one of the key elements of **emtechnik**. As a medium-sized family-owned company, our corporate culture is shaped by flat hierarchies, stability and sustainable growth.

Our daily interactions are marked by teamwork, open communication and short decision-processes. A productive and pleasant work atmosphere is especially important for us as an employer. To ensure that our employees are able to evolve their full potential, we support their professional development and trust in their abilities. This serves as the basis for long-term business success and the sustainable development of the company.



Personnel development

Supporting young people in their personal, social and professional development is the most valuable investment in the future. As a result, we are constantly able to recruit interested and motivated young talents. Provided with trainings they are equipped for entering the professional life.

Social commitment and promoting young people

Team spirit, strategic thinking and the willingness of every individual to contribute are the factors that make a team successful. Because these qualities are also important for success in professional life, we have been offering comprehensive support to youth teams and sports associations in the region since 1990.

Promoting children and youth is a matter of personal commitment for us. In addition to awarding scholarships to students for their research projects, **emtechnik** also supports children's institutions.

Cleanliness Without Compromise

We make no compromises when it comes to the quality requirements of our customers.

This is particularly relevant where modern production processes demand the highest standards of cleanliness and particle-free operations, e.g. in the food and pharmaceutical industry or in medical technology and the semiconductor industry.

emtechnik has an ISO 14644-1 Class 5 clean room since 1997, which was expanded in 2018 to include two ISO 14644-1 Class 7 areas, including sealed doors. In the first area, products can be manufactured under optimal clean room conditions by an in-house injection moulding machine and thus meet the highest requirements.

In the second area, an ultrasonic washing line including its own ultra-pure water production ensures optimal cleaning to guarantee the absence of particles, oil and grease.



ISO
14644-1
Cl. 5

ISO
14644-1
Cl. 7

All clean room areas are connected to each other, which allow for production, cleaning and assembly in a contamination-free atmosphere. Quality control is fulfilled by specially trained personnel. Clean room manufactured products are prepared for transport in special double-welded packaging filled with class 5.0 nitrogen.

All of our products, certified with the high-purity standard, undergo this carefully monitored production process.



Embodying Responsibility

Sustainable thinking not only defines **emtechnik**'s actions in relation to our products' reliability but has also formed one of the main cornerstones of our philosophy for many years. For this reason, we not only use renewable energy sources but also actively apply an integral sustainability concept.

Consistent resource conservation also plays a role in this respect as do energy-efficient production, extensive investments in modern machinery and social responsibility. With fair payment of all employees and a varied continued and advanced training programme, we are constantly investing in people and machines to ensure our quality standard for the long term and continue our company's success.



Uncompromising safety, a long service life and a modular product system are the central features of **emtechnik**'s sustainable quality. We have implemented a production system with minimal logistical distances, where development and manufacturing are closely interlinked and fully documented in our quality management system.

By using only premium speciality plastics, we manufacture products of excellent quality to high technological standards. Our goal is to achieve an environmentally conscious circular economy, where resources are kept in use for as long as possible. To do so, we draw on a sustainable product design and recyclability for our products.

We pay careful attention to sustainability in our procurement logistics and foster long-term, fair working relationships within our supply chain. We favour extensive in-house production to achieve an exceptionally high quality standard. Our needs-based production minimises waste products and storage space requirements, thus helping to reduce emissions.

A combined heat and power unit allows us to generate electricity with European certified rapeseed oil in our own power plant. The heat produced by the generation process and the waste heat from the injection moulding machines are channelled back into the heat cycle via a heating buffer and is used to heat our buildings and production halls. In addition to efficient energy conversion through combined heat and power generation, the use of vegetable oil as a fuel also has a positive effect on resource conservation and climate protection. Rapeseed oil fuel is rapidly biodegradable, does not pollute water and helps to protect soils, water bodies and living beings. We are striving to have a self-sufficient power supply system in the future, which will produce and use heating and cooling energy within the company.



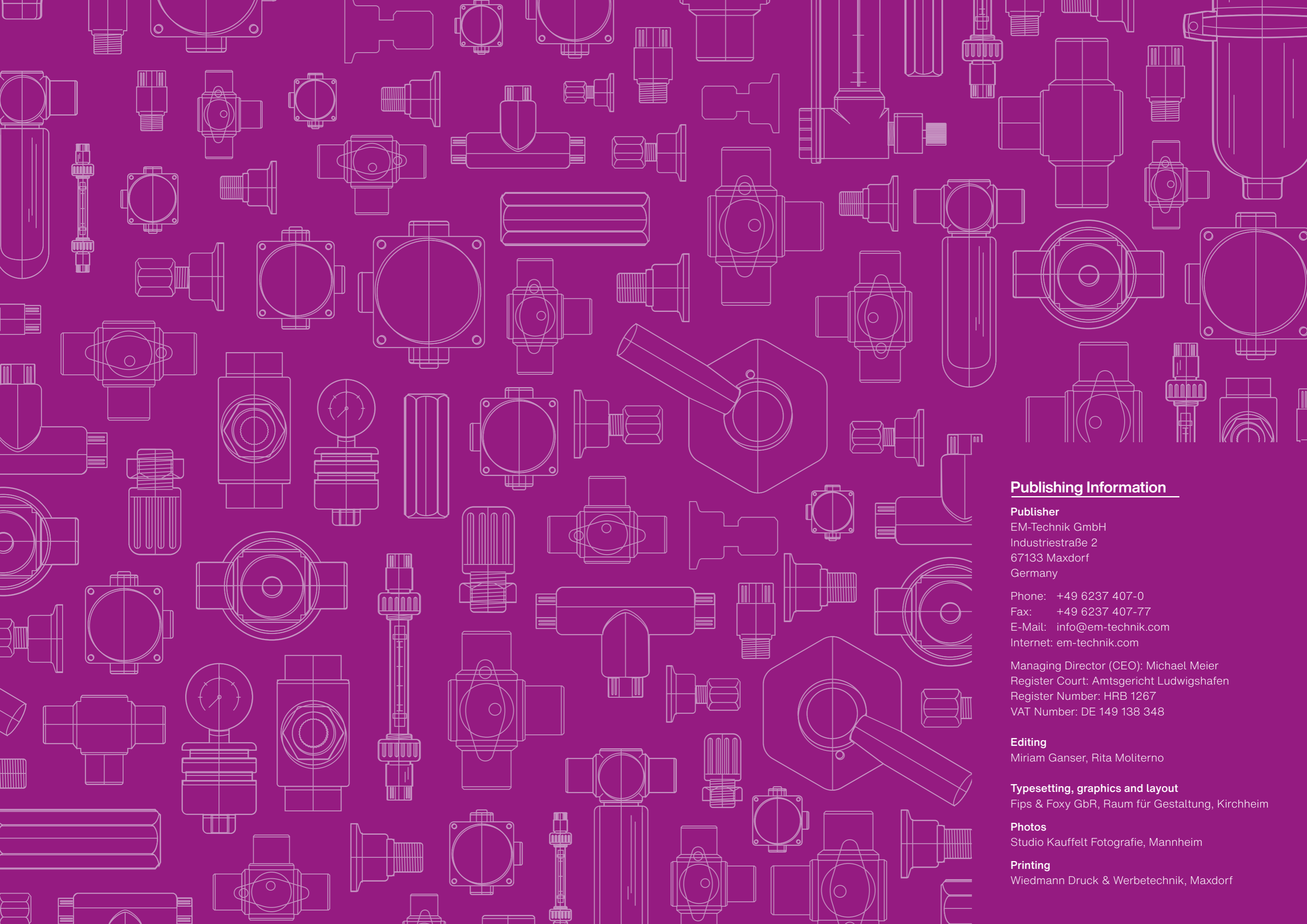

Publishing Information

Publisher

EM-Technik GmbH
Industriestraße 2
67133 Maxdorf
Germany

Phone: +49 6237 407-0
Fax: +49 6237 407-77
E-Mail: info@em-technik.com
Internet: em-technik.com

Managing Director (CEO): Michael Meier
Register Court: Amtsgericht Ludwigshafen
Register Number: HRB 1267
VAT Number: DE 149 138 348

Editing

Miriam Ganser, Rita Moliterno

Typesetting, graphics and layout

Fips & Foxy GbR, Raum für Gestaltung, Kirchheim

Photos

Studio Kauffelt Fotografie, Mannheim

Printing

Wiedmann Druck & Werbetechnik, Maxdorf

emtechnik Worldwide

Germany

EM-Technik GmbH
Industriestraße 2
67133 Maxdorf

Phone +49 6237 4070
Fax +49 6237 40777
info@em-technik.com

Belgium

EM-Technik GmbH
Voortstraat 14
2890 Oppuurs

Mobile +32 479 412 400
em-technik.be@skynet.be

France

EM-Technique SARL
23-24 Rue Nicolas Copernic
ZAC Les portes de l'Oise
60230 Chambly

Phone +33 1 3937 2290
Fax +33 1 3028 1352
info@em-technique.fr

Great Britain

EM-Technik UK Ltd.
Unit 10, Summit Business Park
Lingard Street, Stoke on Trent
ST61ED Staffordshire

Phone +44 1782 980 320
info@em-technik.co.uk

Italy

EM-Technik Italia S.r.l.
Via J. F. Kennedy 19
20871 Vimercate (MB)

Phone +39 039 688 1198
info@emtechnik-italia.it

Netherlands

EM-Technik Holland B.V.
Hyperonenweg 6c
3542 AG Utrecht

Phone +31 30 241 2318
info@em-technik.nl

Poland

EM-Technik Polska sp. z o.o.
ul. Fabryczna 14
53-609 Wrocław

Phone +48 519 034 531
info@em-technik.pl

India

EM-Technik India Pvt. Ltd.
Plot No. 133 + 138
Tiny Industrial Co-op Estate
Kondhwa Budruk
Pune 411 048

Phone +91 20 2693 4072
Fax +91 20 2693 4073
info@em-technik.in

Eastern Asia

EM-Technik East Asia Ltd.
5 FL., No.39 Lane 159,
Fu-Der 1. Road
Shih Chih District, New Taipei City
Taiwan

Phone +886 2 2692 4448
Fax +886 2 2694 8922
steven.chen@em-technik.com.tw

South-East Asia

EM-Technik Asia Pte Ltd.
448 Tagore Industrial Avenue
Singapore 787819

Phone +65 6484 3202
Fax +65 6484 2276
info@em-technik.sg

United Arab Emirates

EM-Technik Middle East
Trading Co. LLC
Level 23, Boulevard Plaza Tower 2
Dubai Downtown, Emaar square
Dubai

Phone +971 55126 4313
info@em-technik.ae

Our Representatives

Finland

YTM-Industrial Oy
Tiilenlyöjänkuja 9 B
01720 Vantaa

Phone +358 29 006 230
Fax +358 29 006 1150
ytm.info@ytm.fi
www.ytm.fi

Sweden

GPA Flowsystem AB
Brovägen 5
26675 Hjärnarp

Phone +46 431 445 800
Fax +46 431 454 666
info@gpa.se
www.gpa.se

Spain

Aplicaciones Tecny Fluor, S.L.
c / Neptuno, 10
08222 Terrassa - Barcelona

Phone +34 93 73610 30
Fax +34 93 73610 31
tecnnyfluor@tecnnyfluor.com
www.tecnnyfluor.com

USA

ASAHI/AMERICA
655 Andover Street
Lawrence, MA 01843

Phone +1 781 321 5409
Fax +1 978 685 3010
asahi@asahi-america.com
www.asahi-america.com